

Instruction Manual

PSx3xxDP

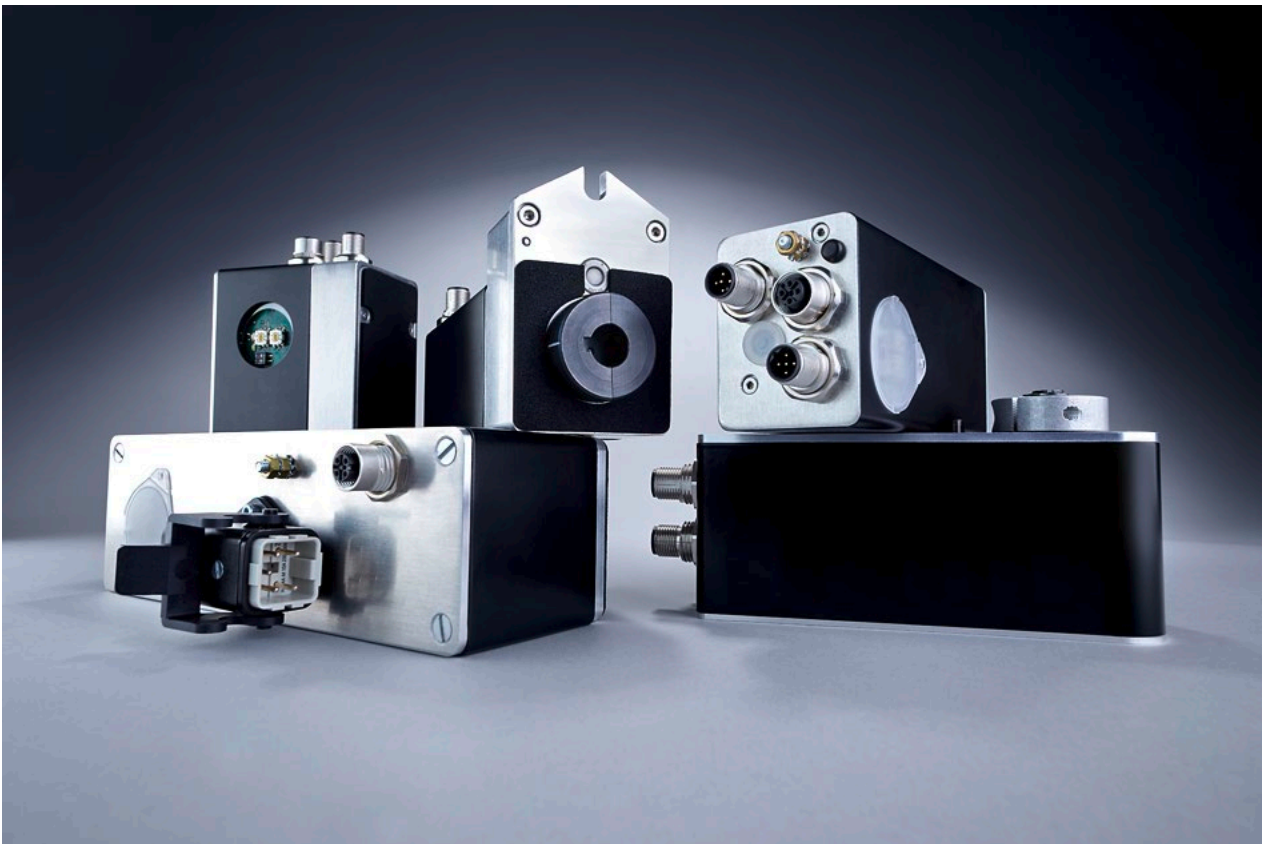

halstrup-walcher GmbH

Stegener Straße 10
D-79199 Kirchzarten

Phone: +49 (0) 76 61/39 63-0

E-Mail: info@halstrup-walcher.com
Internet: www.halstrup-walcher.com

Revision overview

Version:	Date:	Author:	Content:
K	20.01.22	sys	K Nenndrehzahl 3218 korrigiert
L	08.08.23	Ts	revise manual, new information chapt.2.4 powering device, added chapter 4.5 upper mapping end, QR code measurement technology, current consumption "Electrical data" corrected. Unit unified for revolutions. New chapter Limitation of liability and cross-sections Power supply cables. Reference to axial and radial forces in chap. assembly.
M	12.09.23	Ts	Chapter Upper mapping end removed – not available for dp
N	19.06.24	Ts	Error corrections, safety topics, meaning of the operating instructions revised, intended and non-intended use added, limitation of liability revised, new product labeling, assembly chapter revised, vibration and noise emissions in Physical Data added

Translation of the original instructions

© 2024

The manufacturer owns the copyright to this instruction manual. It contains technical data, instructions and drawings detailing the devices' features and how to use them. It must not be copied either wholly or in part or made available to third parties.

These operating instruction is part of the product. Read these instructions carefully, follow our instructions and pay particular attention to safety instructions. The instructions should be available at all times.

Purpose of instruction manual

This instruction manual describes the features of the PSx3xx positioning system and provides guidelines for its use.

Every person who is tasked with carrying out work on or with the appliance must have read and understood the operating instructions before starting work on the appliance. This also applies if the person concerned has already worked with such an appliance or a similar appliance or has been trained by the manufacturer.

These appliances can pose a risk to persons and property due to improper use and incorrect operation. For this reason, every person entrusted with handling the appliances must be trained and aware of the dangers. The operating instruction and in particular the safety instruction contained therein must be carefully observed.

Always contact the manufacturer if you do not understand any parts of these instructions.

Handle these operating instructions with care:

- It must be kept within easy reach for the entire service life of the appliances.
- It must be passed on to subsequent personnel.
- Any supplements issued by the manufacturer must be included.

The manufacturer reserves the right to further develop this device type without documenting this in each individual case. Your manufacturer will be happy to provide you with information on the current status of these operating instructions.

Conformity

This device is state of the art.
It complies with the statutory requirements of the EC and UK-directives.
This is documented by the CE and the UKCA mark being affixed.



Accessoires PSx3xxDP series

We offer you the corresponding supply and data plugs for all unit types. Please contact our sales department, stating the complete type designation, at the following e-mail address

Vertrieb@halstrup-walcher.de

Table of Contents

Purpose of instruction manual	3
Conformity	3
Accessoires PSx3xxDP series	3
Table of Contents	4
1 Safety precautions	7
1.1 Qualified personnel.....	7
1.2 Explanation of symbols.....	7
1.3 Appropriate use	8
1.4 Inappropriate use.....	9
1.5 Limitation of liability	9
1.6 Faults, maintenance, repair, disposal	10
1.7 Product labeling.....	11
2 Device description	12
2.1 Features	12
3 Installation.....	13
3.1 Electrical connection.....	13
3.2 Assembly of the positioning system	14
3.3 Hollow Shaft	14
3.4 Solid Shaft.....	16
3.5 Disassembly	17
3.6 Powering the device	17
3.7 Pin assignment.....	17
3.8 Supply voltage connector (24VDC).....	18
3.9 Round socket for bus (Bus 1 and Bus 2).....	18
3.10 Connector for jog keys (Jog)	18
3.11 Electrical grounding (Chassis).....	18
3.12 Setting the device address and terminating resistors	19
3.13 LED status	20
3.14 Using the bus to set the address.....	20
3.15 Using the parameter module to set the address (firmware version 8).....	20
4 Jog key operation	21
4.1 Connecting the jog key inputs.....	21
4.2 Using the control unit to activate the jog keys	22
4.3 Direct positioning using the jog keys.....	22
4.4 Incremental manual operation	22
4.5 Incremental operation.....	22
5 Start-up	23
5.1 Setting the reference position	23
5.2 Positioning sequence.....	23
5.3 Positioning sequence (without reference loop).....	24
5.4 Reverse drive	24
5.5 Devices with optional snap brake.....	25
5.6 Devices with optional holding brake.....	26
6 Interface.....	27

6.1	Status byte configuration	27
6.2	Target position reached	27
6.3	Drive running	27
6.4	Motor supply voltage OK	28
6.5	Ready	28
6.6	Hardware error	28
6.7	Positioning run aborted	28
6.8	Jog key, down	28
6.9	Jog key, up	28
6.10	Temperature too high	28
6.11	Drag error	28
6.12	Invalid target/parameter value	28
6.13	Positioning error	29
6.14	Manual rotation	29
6.15	No supply voltage available to motor	29
6.16	Upper range limit	29
6.17	Lower range limit	29
6.18	Actual position	29
6.19	Control byte configuration	30
6.20	Confirmation	30
6.21	Release bit	30
6.22	Manual run release	30
6.23	Run with no reference loop	30
6.24	Set value for reference position	30
6.25	Set and save reference position	30
6.26	Accept and proceed to position	31
6.27	Manual run, down	31
6.28	Manual run, up	31
6.29	Target position	31
6.30	Parameters	31
6.31	Direction of rotation	32
6.32	Direction of travel	32
6.33	Position correction	32
6.34	Jog key operation	33
6.35	Hardware resolution	33
6.36	Software resolution	33
6.37	Positioning window	33
6.38	Max. run distance, positive	33
6.39	Max. run distance, negative	33
6.40	Target rpm, positioning run	33
6.41	Target rpm, manual run	34
6.42	Max. rpm, left	34
6.43	Max. rpm, right	34
6.44	Max. torque	34
6.45	Max. torque, left	34
6.46	Max. torque, right	34
6.47	Max. starting torque	34
6.48	Duration of starting torque	34
6.49	Holding torque	34
6.50	Drag error	34
6.51	Min. rpm for detecting an obstacle	35
6.52	Time required to detect an obstacle	35
6.53	Wait time between runs	35
6.54	Min. supply voltage	35
6.55	Filter value for voltage monitoring	35
6.56	Loop length	35

6.57	Jog key increment size.....	35
6.58	Jog key pause.....	35
6.59	Factor for ramp length.....	35
6.60	Limiting temperature	36
6.61	Reference position MSW.....	36
6.62	Reference position LSW.....	36
6.63	Production date.....	36
6.64	Serial number.....	36
6.65	Device type	36
6.66	Software version	36
6.67	Hardware version.....	36
6.68	Device temperature.....	36
6.69	Actual rpm.....	36
6.70	Max. actual torque (current)	36
6.71	Run time MSW.....	37
6.72	Run time LSW.....	37
6.73	Drag position.....	37
6.74	Motor supply voltage.....	37
6.75	Motor current.....	37
6.76	Supply voltage for control unit	37
6.77	Error code.....	37
6.78	Changing parameter values	38
7	Backing up parameter data and the error memory.....	39
8	Technical data	40
8.1	Drive speed and torque PSE	40
8.2	Drive speed and torque PSE and PSS	40
8.3	Drive speed and torque PSW	41
8.4	Ambient conditions	41
8.5	Electrical data.....	42
8.6	Physical data.....	43
9	Certificate of Conformity	44

1 Safety precautions

This section provides an overview of all the important safety aspects for optimum protection of personnel and for safe and trouble-free operation.

1.1 Qualified personnel

These operating instructions are intended for qualified electricians and fitters who are authorized to install, electrically connect, commission and label devices and systems in accordance with safety standards, as well as for the operator and manufacturer of the system on which the drives are installed.

The personnel must be provided with all applicable accident prevention and safety regulations that arise during commissioning or installation of the system.

It must be ensured that the personnel are familiar with all applicable accident prevention and safety regulations.

1.2 Explanation of symbols

In these operating instructions, the following highlights are used to draw attention to the hazards described below when handling the system:

⚠ DANGER	DANGER! Indicates a situation of imminent danger, which will lead to a fatality or serious injuries if not prevented.
⚠ WARNING	WARNING! Indicates a potentially dangerous situation, which may lead to a fatality or serious injuries if not prevented.
⚠ CAUTION	CAUTION! Indicates a potentially dangerous situation, which may lead to minor/slight injuries if not prevented.
NOTICE	NOTICE Indicates a potentially harmful situation, which may lead to material damage if not prevented.

1.3 Appropriate use

Positioning systems are especially suitable for automatically setting tools, stops or spindles for wood-processing equipment, packing lines, printing equipment, filling units and other types of special machines.

PSx3xx positioning systems are not stand-alone devices and may only be used if coupled to another machine.

 WARNING
Personal injury and property damage due to incorrect use of the products!

The positioning systems are designed for use in an industrial environment and may only be used as intended. If they are not used as intended, situations may arise that result in damage to property and personal injury.

NOTICE
The device is used as intended if all instructions and information in these operating instructions are observed.

- Only operate the device in perfect technical condition
- When attaching to a machine, observe the current safety regulations.
- Do not operate the product in all installed state unless all necessary protective measures have been taken.
- Observe the relevant regulations for the prevention of accidents (e.g. accident prevention regulations).
- In order to avoid the risk of accidents due to contact with moving parts, appropriate separating or non-separating guards must be provided.
- Use appropriate protective equipment (e.g. safety helmet, safety goggles, safety shoes, protective gloves).
- Use appropriate assembly and transport equipment.
- Store and transport the product in its original packaging, reuse protective caps for plugs if necessary.
- Adequate ventilation must be provided at the point of use to avoid excessive heating.
- During project planning, ensure that the device is always operated within its specifications. See technical data in chapter 8. Technical data and as from chapter 8.1 Drive speed and torque PSE.
- If the device is equipped with a brake, it is not a safety brake that may be used for safety functions.
- In special areas of application such as the chemical, pharmaceutical or food sector, the positioning system in stainless steel design is possible.

1.4 Inappropriate use

The use of the positioning devices outside of the operating conditions and technical data and specifications described in the documentation is considered “improper”.

The drives are designed for intended operation under normal ambient conditions (according to EN / IEC / UL 61010-1), with the exception of an extended temperature range.

- Operation inside buildings
- Operation at altitudes up to 2000m above sea level
- Ambient temperatures deviating from standard: 0°C to 45°C
- Maximum relative humidity 80% at temperatures up to 31°C, decreasing linearly to 50% relative humidity at 45°C
- Fluctuations in the supply voltage up to $\pm 10\%$ of the nominal voltage at 50% relative humidity at 45°C
- The IP-protection rating is a manufacturer specification.

Any use of the device that goes beyond the intended use and/or is used differently can lead to dangerous situations

- Underwater usage of the PSW is not allowed
- The positioning system cannot be used for certain applications, such as the transport of people and animals or as a press-bending device for cold processing of metal.
- If the operation requirements stated in chapter 8. Technical data and as from chapter 8.1 Drive speed and torque PSE are exceeded, personal injury or property damage may occur.
- The positioning system cannot be used in hazardous areas.
- The holding brake must not be used to brake the motor.
- Under no circumstances may the housing cover be used for power transmission purposes, e.g. for supporting, climbing or similar.

1.5 Limitation of liability

The device may only be operated in accordance with these operating instructions. All information and instructions in these operating instructions have been compiled taking into account the applicable standards and regulations, the state of the art and our many years of experience and knowledge.

The manufacturer accepts no liability arising from improper or unintended use. Warranty claims also expire in this case:

- non-observance of the operating instructions
- improper use
- improper installation
- improper use
- Use by untrained personnel
- Modifications to the device
- Technical modifications
- Unauthorized modifications

The user is responsible for carrying out commissioning in accordance with the safety regulations of the applicable standards and all other relevant national or local regulations regarding conductor dimensioning and protection, grounding, circuit breakers, overcurrent protection, etc. The person who carried out the assembly or installation is liable for any damage caused during assembly or connection.

1.6 Faults, maintenance, repair, disposal

Faults or damage to the appliance must be reported immediately to the specialist personnel responsible for the electrical connection.









The appliance must be taken out of operation by the responsible specialist personnel until the fault has been rectified and secured against accidental use.

The appliance requires no maintenance.

Repair work that requires the housing to be opened may only be carried out by the manufacturer.

The electronic components of the appliance contain environmentally harmful substances and are also recyclable materials. The device must therefore be recycled after its final decommissioning. The environmental guidelines of the respective country must be observed.

1.7 Product labeling

Warning symbol	Meaning
	Reference to further documentation Read the operating instructions and safety instructions before transportation, installation or commissioning
	Warning of hot surface The appliance can become very hot during operation. Temperatures of over 70°C can occur. In the event of a fault, internal components may be overloaded. Use personal protective equipment or wait long enough for the appliance to cool down.
	Warning of dangerous electrical voltage Before working on the product, check that all power connections are de-energized!
	Disposal of batteries, electrical and electronic equipment <ul style="list-style-type: none"> • In accordance with international regulations, batteries, rechargeable batteries and electrical and electronic equipment must not be disposed of with household waste. • The owner is legally obliged to dispose of these devices properly at the end of their service life. • WEEE: This symbol on the product, its packaging or in this document indicates that a product is subject to these regulations.
	CE marking CE stands for "Conformité Européenne". The CE marking expresses the conformity of a product with the relevant EC directives.
	UKCA marking UKCA stands for "UK Conformity Assessed". The UKCA marking expresses the conformity of a product with all applicable legal requirements of the United Kingdom.
	Safe torque off Corresponds to stop category 0 in accordance with EN 60204-1. The power supply to the drive is interrupted immediately and the drive is brought to an uncontrolled standstill
	GROUNDING Chassis grounding (description in chapter 3.11 Electrical grounding (Chassis))

2 Device description

2.1 Features

The PSx3xx positioning system, an intelligent, compact, complete solution for positioning auxiliary and positioning axes, consists of an EC motor, gear power amplifier, control electronics, absolute measuring system and Profibus DP interface. The integrated absolute measuring system eliminates the need for a time-consuming reference run. Connecting to a bus system simplifies the wiring. A hollow shaft with adjustable collar makes assembly quite simple. The positioning system is especially suitable for automatically setting tools, stops or spindles for wood-processing equipment, packing lines, printing equipment, filling units and other types of special machines.

PSx3xx positioning systems convert a digital positioning signal into an angle of rotation.

NOTICE

If the device names are given without the diameter of the output shaft (8, 14), the relevant information is valid for all offered output shafts (applies throughout the document).

'x' in the device name stands for a number in the range 0...9. 'xx' in the device name stands for a number in the range 10...999.

3 Installation

3.1 Electrical connection

NOTICE

The following notes on the power supply should be observed.

Minimum cross-sections are required for connection to the power supply. For power cables mounted on the device, use only the cross-sections listed below. In order to minimize voltage drop on longer cables, we always recommend using the largest available cross-section.

Device	Cable cross-section
PSEx31 / PSx32 / PSx33	min. AWG20 or 0,5 mm ²
PSEx34	min. AWG18 or 1,0 mm ²
Fieldbus connections	min. AWG23 or 0,25 mm ²

If there are concerns about mechanical strength or where cables may be exposed to mechanical damage/stress, they must be protected accordingly. This can be ensured, for example, by a cable duct or a suitable armoured pipe.

If the power supply cables are laid in the immediate vicinity of the drives or other heat sources, make sure that the cables have a temperature resistance of at least 90°C. With suitable design measures, e.g. sufficient ventilation or cooling, lower temperatures are also permissible. This must be checked and determined by the customer.

Make sure that the flammability class of the cable for the USA is equivalent to UL 2556 VW-1, e.g. according to IEC 60332-1-2 or IEC 60332-2-2 depending on the cross-section. For Canada, the flammability class FT1 is required, FT4 exceeds this and is therefore also permissible. Cables for the North American market often meet both requirements. However, the flammability class requirements only apply if you do not limit to Class 2 (e.g. certified power supply) or to <150 W according to UL 61010-1
→3.6 Powering the device by means of a suitable fuse.

When installing in North America, please observe the specifications in the National Electrical Code NFPA 70 and the Electrical Standard for Industrial Machinery NFPA 79 (USA) or the Canadian Electrical Code and C22.2 (Canada) in the respective valid version.

Note the limitations of liability → 1.5 Limitation of liability.

3.2 Assembly of the positioning system

CAUTION

The maximum permissible axial and radial forces (see chapter 8.6 Physical data) on the motor shaft must not be exceeded during transportation, installation or operation.

CAUTION

Take the weight of the device into account when selecting the fastening screws! Tightening torques of the fixing screws according to the screw manufacturer's specifications!

WARNING

Rotating and/or linearly moving components can cause serious injuries. If there is a risk of accidents during installation or operation, the moving parts must be fitted with guards or protective devices.

NOTICE

Temperature overload

The PSx3xx positioning unit has a simple temperature measuring device to prevent thermal overload. If the temperature in the device exceeds the limit temperature set in the parameterization, this bit is set and repositioning is only possible after the device has cooled down ('Temperature exceeded' bit reset).

3.3 Hollow Shaft

The PSx3xx is mounted on the machine by sliding it with the hollow shaft onto the spindle to be driven and fixing it with the clamping ring (recommended shaft diameter 8 h9 or 14 h9; tightening torque of the clamping ring screw with 3 mm hexagon socket: 1.5 Nm).

CAUTION

The depth of the hollow bore is 20 mm. For optimum operation, the pin of the shaft to be driven should correspond to this depth. Depending on the operating situation, significantly shorter pins (< 16 mm) may cause damage to the PSx3xx. When mounting the PSx3xx, it should only be pushed on until the foam rubber plate lies evenly on the bottom of the machine or is compressed to approx. half its thickness. Under no circumstances may the PSx3xx "hard" be screwed to the machine without an air gap.

The rotation lock is made via the pin (in the picture below the hollow shaft) into a suitable bore as rotary torque support. This hole must be slightly larger than the diameter 6 h9 of the pin. An oblong hole or slot with a slightly larger width (recommended: 6.05...6.10 mm)

than the dimension of the pin diameter is optimal. The backlash when changing the direction of rotation has a direct influence on the positioning accuracy and can lead to damage to the PSx3xx with very large backlash (a few mm) due to the impact load.



CAUTION

The PSx3xx must have a little gap on all sides when mounted, as it can move axially and/or radially during positioning if the hollow shaft and solid shaft are not 100% aligned. This "staggering" is not a defect of the PSx3xx and also has no influence on the function, as long as it can move freely. Please note the maximum permissible radial force and axial force in chapter → 8.6 Physical data.

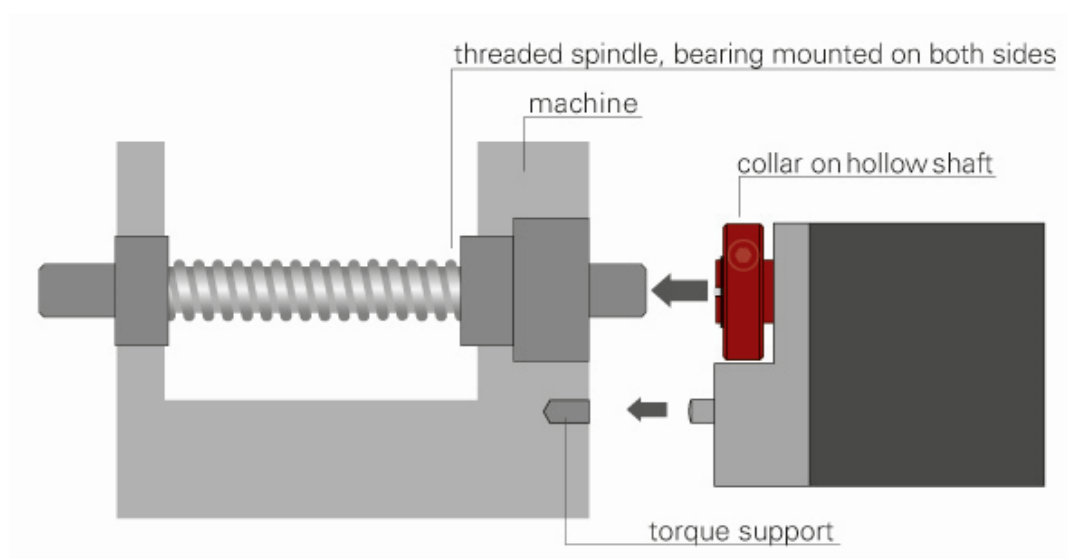

Versions with higher torques (from 10 Nm):

Here the force connection is made via a feather key DIN 6885-A5x5x12.

The clamping ring is not freely rotatable but consists of two halves, the fixed part of the hollow shaft and the loose clamping clamp. The keyway is located in the half that is fixed to the output shaft. When sliding onto the shaft to be driven with the key inserted, its angular position must be aligned with the keyway in the PSx3xx. After pushing on, the PSx3xx is fixed with the 2 screws in the flexible clamping ring half. Make sure that both screws are tightened as equally as possible (tightening torque of the screws with 3 mm hexagon socket: 1.5 Nm).

The information on torque support applies in the same way as described above.

For PSE30x-14, PSE32x-14, PSS30x-14 and PSS32x-14, the position of the anti-rotation lock can be set at greater distances by unscrewing the base cover, turning it 180° and then screwing it back on. When screwing on, make sure that the seal is correctly inserted in the floor.

For torques > 5 Nm we recommend to choose the greater distance.

3.4 Solid Shaft

The PSx3xx is installed on the machine by mounting the drive to the axis to be driven using a coupling and an intermediate flange.

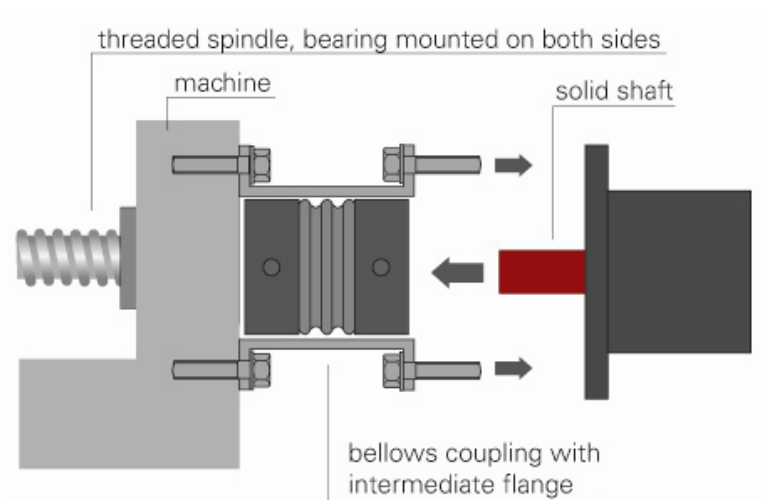

CAUTION

Under no circumstances may the housing cover be used for the purpose of the transmission of force.

CAUTION

Never apply force to the housing cover, e.g., for supporting weight.



3.5 Disassembly

To remove the PSx3xx from the shaft, release the clamp (for versions with hollow shaft the clamping ring) and pull the PSx3xx off the shaft. If possible, the PSx3xx should only be pulled axially. Excessive bending back and forth can damage the output shaft!
For versions with brake, it is essential to observe the instructions in sections 5.5 Devices with optional snap brake and 5.6 Devices with optional holding brake!

3.6 Powering the device

 CAUTION
<p>For motor power use a single fuse with max. 3,5 A for each PSx3xx. For motor power use a single fuse with max. 10 A for each PSE34xx. For control power you can use a fuse with max. 2,0 A, so it is possible to power up to 10 units parallel with one fuse. It is strongly recommended to separate power cables to the PSx3xx from other power cables that might have dangerous voltage.</p>

 CAUTION
Underwater usage of the PSW is not allowed.

 CAUTION
 Please consider that the device might have a hot surface during operation!

3.7 Pin assignment

NOTICE
Care must be taken to ensure that the mating connectors and the cables used match the connectors in the PSx3xx and are fitted correctly in order to achieve the IP protection class.

3.8 Supply voltage connector (24VDC)

connector pattern (external top view)	assignment	type
	<ol style="list-style-type: none"> +24V motor GND motor +24V control unit GND control unit housing/pressure balance 	PSE/PSS: M12 (A-cod.); 5-pol. PSW: M12 (A-cod.); 4-pol. with airtube
	<ol style="list-style-type: none"> +24V motor GND motor +24V control unit GND control unit housing/pressure balance 	PSE34xx: HAN4A, Harting

NOTICE

To prevent the ingress of fluids into the PSW-housing during cooldown, use a special cable with an airtube for pressure balancing of your PSW.

3.9 Round socket for bus (Bus 1 and Bus 2)

	<ol style="list-style-type: none"> VP +5V RxD/TxD-N / A line DGND (reference potential to VP) RxD/TxD-P / B line shield 	M12 (B-cod.); 5-pol.
--	--	-------------------------

NOTICE

Due to the use of 5-pin sockets, only five-wire cables should be used.

3.10 Connector for jog keys (Jog)

connector pattern (external top view)	assignment	type
	<ol style="list-style-type: none"> +24V output (=+24V control in supply voltage connector) forward key reverse key ground (= GND control unit) 	M8; 4-pol.

3.11 Electrical grounding (Chassis)

Next to the connecting plugs there is a M4 stud bolt. It is recommended to connect the positioning system with a cable as short as possible to the machine base. The minimum wire cross section therefor is 1.5mm².

3.12 Setting the device address and terminating resistors

Removing the protective cap provides access to two rotary switches for setting the device address and a DIP switch to set the terminating resistors.

The rotary switches indicate the tens and ones places of the address selected. A setting of 01 is the delivery state; the PSx3xx identifies itself using address 1 at the bus.

To activate the terminating resistors both switches must be in position ON (If active, remove the connection to a following device).

Switch configurations:

PSx30xDP,
PSx31xDP-8,
Pxx32xDP,
PSx31xxDP

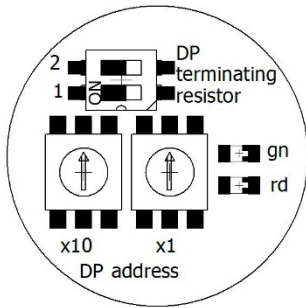

PSx31xDP-14,
PSx33xDP-14

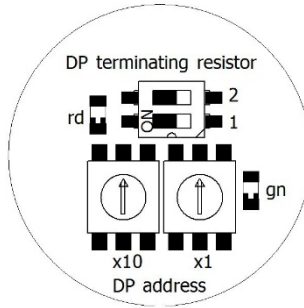

PSx34xxDP

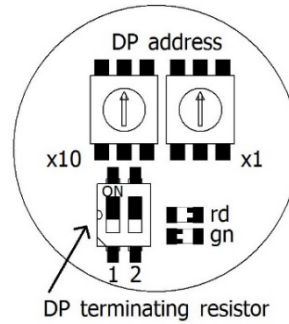

CAUTION

Important: Always replace the protective cap after setting the address. This will prevent dust and contaminants from entering the instrument.

3.13 LED status

The red LED indicates the operating status of the Profibus DP.

LED status	Meaning
LED remains lit	The Profibus DP is not connected or is inactive
LED flashes	The instrument has detected data transfer activity on the bus and identified the transfer rate.
LED is not lit	Provided the power supply is switched on, an unlit LED indicates that the instrument is involved in bus communication.

The green LED indicates the status of the power supply.

LED status	Meaning
LED remains lit	Power supply of control unit and motor is activ
LED flashes	Power supply of the motor is inactive.
LED is not lit	Power supply of the control unit is inactive. The status of the motor supply could not be detected in this case.

3.14 Using the bus to set the address

The Profibus DP can also be used to set the device address, provided the address switch is set to 00. In the delivery state, the instrument will identify itself using address 100. Various devices (such as the BW1311 Profibus Master Simulator, see link below) can be used to change this address. The address is then saved and can be used to communicate with the instrument the next time it is switched on. The address set at the address switches always takes precedence, i.e., if an address other than 00 has been set at the address switch, this address is always used for communication with the instrument.

Link to Profibus Master Simulator BW1311:

<http://www.bihl-wiedemann.de/en/products/bus-couplersmaster-simulators/product-overview-bus-couplersmaster-simulators//bw1131.html>

NOTICE

Using the address switch instead of the bus to set the Profibus address offers numerous advantages and more safety. As such, the bus should only be used for settings when absolutely necessary.

3.15 Using the parameter module to set the address (firmware version 8)

The parameter module can also be used for setting the device address via the bus if no bus assistant is available for setting the address.

The instrument is projected using the 100 address. Only the 'parameter' module and the status byte are required. The following settings are set to the device once bus communication has been initiated.

Parameter index = 126(0x7E)
 Parameter data out = 170(0xAA) → The 'hardware error' bit is activated in the status byte

Parameter index = 52(0x34) index → DP address

Parameter data in = 0000 set by the instrument
Parameter data out = new DP address

Parameter index = 180(0xB4) index → write DP address
Parameter data in = 0000 set by the instrument
Parameter data out = new DP address

The instrument saves the address and resets, after which communication with the instrument can only occur via the new DP address.

The device address for all halstrup-walcher Instruments is 100 by default. If you wish to incorporate an address change into an SPS project and do not want to use 100, the address can be changed for a projected address. In this event, all instruments to be incorporated into the project must be preset to this address (ex.: 50). The bus then accepts the device with this address (ex.: 50) for data transfer, introduces the transfer driver and resets to the new address. The transfer driver and the driver with the address change function can then be reinstalled.

4 Jog key operation

4.1 Connecting the jog key inputs

The jog key inputs can be used in 2 different wiring modes:

- Connection of potential-free switches

To activate the respective jog key input, the +24V in the jog key plug is connected here. The GND connection in the jog key plug remains unused.

The 24V output in the jog key plug is internally connected to the +24V control in the supply plug. It is therefore also possible to connect the jog button inputs directly to the +24V control potential via switches.

- Connection of an active signal

Here the respective jog key input is connected to the (active) signal connection.

The reference ground of the external active signal should be connected to the GND connection in the jog key plug.

The +24V output in the jog key plug remains unused.

The GND connection in the jog key plug is internally connected to the GND control in the power supply plug. If the connected active jog key signal has the same GND potential as the GND control, the wiring of the GND connection in the jog key plug can be omitted.

Connection examples:
potential-free switches

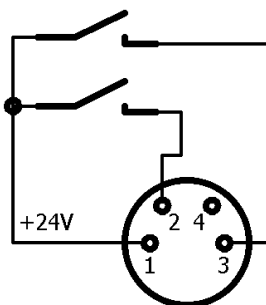

active signals e.g. from a PLC

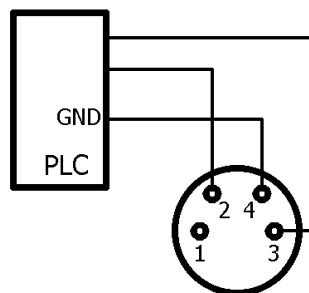

4.2 Using the control unit to activate the jog keys

The jog keys are inactive by default. The jog key status is copied into the status byte, giving the user the ability to activate jog key functions from the control unit. This only works, however, if the release has been set in the command byte and the 'accept and proceed to position' bit has not been set. Jog key bits can now be copied from the status byte to the command byte, and the drive may begin a positioning sequence. This also allows operators to use the control unit as a means of executing a positioning sequence at one drive using the jog keys of another drive.

4.3 Direct positioning using the jog keys

Direct jog key positioning requires that the jog key function be released, either when setting parameters or by means of the 'manual run release' bit in the command byte. The 'release' bit must be set and the 'accept and proceed to position' bit must not be activated. Any jog key input will now be executed directly by the drive.

4.4 Incremental manual operation

When a jog key is depressed, the drive will move by the distance specified in the 'jog key increment size' parameter. The instrument will then wait for the amount of time specified by the 'jog key pause' parameter. If the key remains depressed, the drive will resume operation at manual speed and will continue until either the key is released or a second key is depressed. This pause was introduced so that users would have sufficient time to release the key in order to position the drive in individual increments.

4.5 Incremental operation

Setting the 'jog key pause' parameter to zero will suppress manual operation, making it possible to operate the drive solely in increments.

5 Start-up

5.1 Setting the reference position

Once it has been installed, the PSx3xx must be moved to the reference position, either via the jog keys or with a positioning command. The 'set reference position' command (see section entitled 'Command byte configuration') is used to set the internal position of the PSx3xx to zero. This position is saved by the instrument and used as a reference for all positioning data and ranges.

Position 0000 was assigned to the reference point for firmware version 6 and lower. Beginning with firmware version 7, however, the reference position is assigned the value of the module target position. The reference position and assigned position are both permanently stored in the instrument.

5.2 Positioning sequence

The PSx3xx distinguishes between the following steps of a positioning sequence (It is assumed that all target positions are approached via forward motion.)

1. New setpoint position is greater than the current actual position: The target is approached directly.

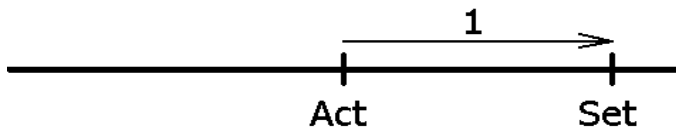

2. New setpoint position is smaller than the current actual position: The device is moved further back by the loop length (2a) and the final destination is then approached in forward motion (2b).

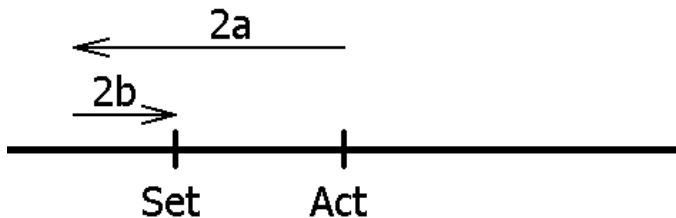

3. New setpoint position is only slightly larger than the current actual position and previously there was no positioning movement with loop (e.g. a manual movement): In all cases, the drive approaches the target with a forward movement whose length corresponds at least to the loop length. In order to achieve this, the drive first moves in reverse direction (3a), i.e. against the actually desired direction of travel, and then forwards the actual destination (3b).

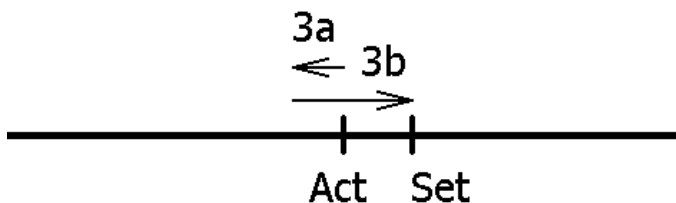

The maximum length of this distance is the loop length. If the setpoint differs from the current actual value by more than the loop length, it is approached directly

After reaching the target position, this position is compared with the internal absolute encoder status. If there is a deviation, the status bit "positioning error" is set.

In the delivery state, the loop length is -250, i.e. each setpoint position is approached in the forward direction.

5.3 Positioning sequence (without reference loop)

The "positioning without a reference loop" mode is used primarily for moving the small distances involved in fine adjustments. In this case, each position is approached directly. This does NOT eliminate any play present in the spindle in question. The PSx3xx internal gear backlash does not play a role in this case, as position data are acquired directly at the output shaft.

 CAUTION
Underwater usage of the PSW is not allowed.

5.4 Reverse drive

In vertical positioning with spherical roller spindles, pitches of approx. 4..10 mm and weights from 100 kg, it is possible that the PSx3xx does not consume any energy from the motor supply when travelling downwards, but rather generates some. This regenerative operation is permissible under certain conditions. The energy generated is fed back into the motor supply network via the internal regenerative circuit and must be drawn off there. The PSx3xx increases the voltage in the motor supply network until the additional energy is drawn off. However, the internal protection diode limits this voltage to max. 31 VDC. The following cases should be considered:

- 1) If several PSx3xx and/or other loads are connected to the same power supply, regeneration is possible without any additional measures if several PSx3xx do not generate power simultaneously. The other devices then act as consumers of the energy generated by a PSx3xx.
- 2) If several PSx3xx are to use the regenerative circuit simultaneously, an overvoltage protection must be provided in the motor supply network.

If a PSx3xx is operated for more than 1-2 seconds in regenerative mode without consumer of the generated energy, this damages the internal protection diode and the PSx3xx is defective.

5.5 Devices with optional snap brake

The device models PSx30x-14, PSx31x-14, PSx32x and PSx33x can be supplied with an optional snap brake. This brake prevents the output shaft from turning when the power supply to the motor is removed, or, if the motor holding torque is too low, to a maximum of the level of the nominal torque. A small degree of rotation always occurs at the output, i.e. the brake cannot be used to hold the drive at a defined position (for this purpose the holding torque may have to be increased).

To release the brake when a run command is transmitted, these devices first wait for a short time and then run a few increments against the actual direction of movement. The brake is closing at the end of every run.

Manual turning:

When mounting or dismounting a PSx3xx, it may be necessary to manually turn the output shaft to a certain position. For this purpose, the actuators are equipped with a manual adjustment facility:

First, the corresponding cover in the cover must be removed.

Then use a NW3 (PSx31x, PSx33x, or NW4 (PSx30x, PSx32x) hexagon key to disengage the brake by pressing it down and turn it simultaneously.

An electrical release of the brake via Bus is not possible on its own (without travel job).

⚠ CAUTION
The drive must not be turned into another position with an electric screwdriver.

⚠ CAUTION
Important: Always replace the protective cap after setting the address. This will prevent dust and contaminants from entering the instrument.

⚠ CAUTION
A "forced" turning of the drive without disengaging the brake leads to the destruction of the brake and thus of the drive!

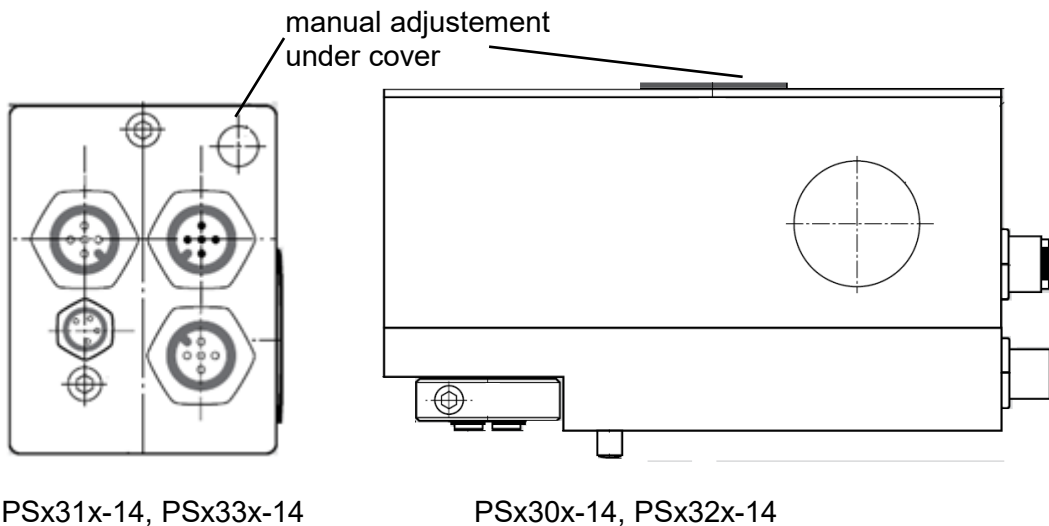

5.6 Devices with optional holding brake

The device model PSE34xx can be supplied with an optional holding brake. This brake prevents the output shaft from turning when the power supply to the motor is removed, or, if the motor holding torque is too low.

A run command is not approached immediately but only after a short idle period to tighten the brake.

The brake releases at the end of every run.

To adjust the drive manually, it is first necessary to remove the corresponding rubber-plug in the top cover (see drawings at the end of these instructions). The drive can then be rotated using a hex wrench NW4. This is quite difficult as the operator has to overcome both any torque present at the output and the force of the friction brake.

The brake is not damaged by manual rotation.

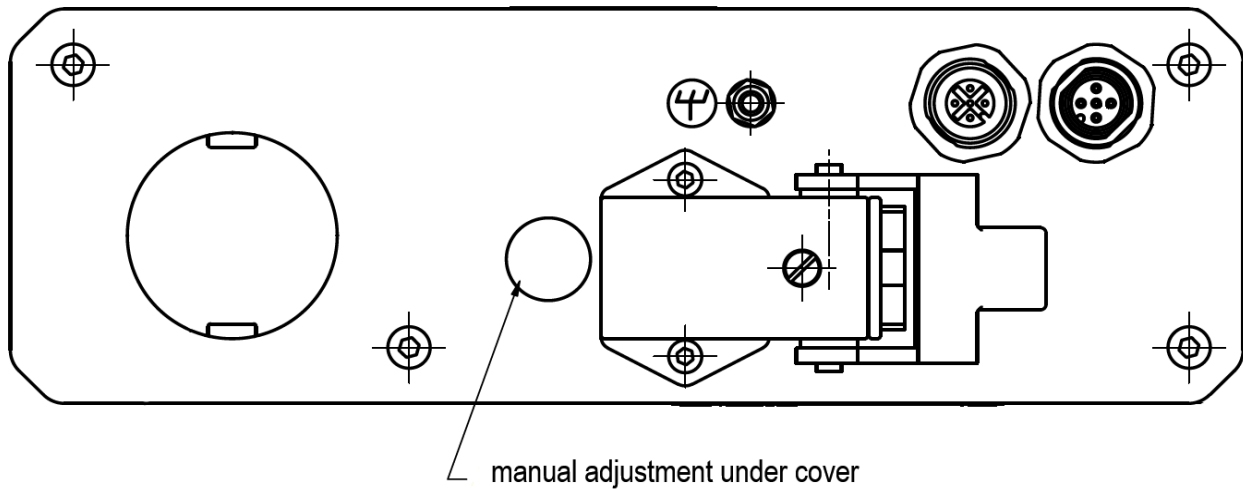

6 Interface

Modules	Format	Meaning
status byte	16 bit	flags for instrument status
actual position	signed long 32 bit	current actual position in target-value increments
command byte	16 bit	flags for controlling the instrument
target position	signed long 32 bit	next position to be achieved in target value increments
parameters	8 bit index signed int 16 bit data in signed int 16 bit data out	set and/or read out parameters, indexed
actual index	8 bit	index of the parameter that has been read out

The status byte provides the user with information on the current status of the PSx3xx. The actual position indicates the current position at which the positioning unit is located. The command byte is used to transmit commands to the positioning unit. The target position is used for transmitting the next position to be reached. During operation, the parameter module allows users to adjust instrument settings directly (via the control unit) that could otherwise only be modified when setting parameters.

6.1 Status byte configuration

Bit	Hexadec.	Meaning
15(MSB)	0x8000	target position reached
14	0x4000	drive running
13	0x2000	motor supply voltage OK
12	0x1000	ready
11	0x0800	hardware error
10	0x0400	positioning run aborted
9	0x0200	jog key, down
8	0x0100	jog key, up
7	0x0080	temperature too high
6	0x0040	drag error
5	0x0020	invalid target / parameter value
4	0x0010	positioning error
3	0x0008	manual rotation
2	0x0004	no supply voltage available to motor
1	0x0002	positive range limit
0(LSB)	0x0001	negative range limit

6.2 Target position reached

The drive is at the target position \pm the permissible deviation defined by the positioning window.

6.3 Drive running

The drive is performing a positioning run.

6.4 Motor supply voltage OK

The power supply to the motor is higher than the value indicated in the 'min. supply voltage' parameter. This bit must be set prior to performing a run. The level of the supply voltage has a significant effect on the torque and/or motor speed.

6.5 Ready

Supply voltages, temperature and target position are all in the permissible range and the drive can begin operation. An exception here is when the display indicates a hardware error, which the operator must acknowledge (thereby deleting the error message) before performing the run.

6.6 Hardware error

This bit is set if an error is detected during an internal process and causes the drive to stop. The 'error status' parameter can be used to determine the source of the error. This bit can be deleted by temporarily deactivating the release bit in the command byte, an action that causes the error to be recorded in an internal error memory. The 'save' command can be used to save this error memory in the instrument's non-volatile EEPROM.

6.7 Positioning run aborted

The positioning run has been aborted, either because the release bit was reset or because of an error.

6.8 Jog key, down

This bit indicates that the 'down' jog key has been depressed. A manual run can be performed directly either if the 'manual run release' bit in the command byte has been activated or if the manual run was released when setting parameters and the positioning bit has not been set.

6.9 Jog key, up

This bit indicates that the 'up jog key' input has been activated (connected to +24V). A manual run can be performed directly either if the 'manual run release' bit in the command byte has been activated or if the manual run was released when setting parameters and the positioning bit has not been set.

6.10 Temperature too high

The PSx3xx positioning unit is equipped with a simple temperature monitoring device intended to avoid a thermal overload. This bit is set if the temperature inside the instrument exceeds the temperature limit set in the parameters; new positioning runs can only be performed once the instrument has cooled down (the 'temperature too high' bit is reset). The 'temperature too high' bit must be reset with the confirmation bit.

6.11 Drag error

If the load moment prevents the drive from achieving the target rpm, the current position will not agree with that for the target rpm, a situation that can cause problems when multiple drives are running in parallel. The 'drag error' parameter allows the user to establish the maximum discrepancy. This bit is activated if the difference exceeds that of the set value; the run is not interrupted. The action required to eliminate this problem must be monitored by the external control unit.

6.12 Invalid target/parameter value

The operator has attempted to enter a target value or a parameter that lies outside of the valid range.

6.13 Positioning error

After the positioning run, the difference between the actual and target values is larger than the positioning window. The bit is deleted during the subsequent positioning run.

6.14 Manual rotation

Following a positioning run, an external load moment was applied to the drive, rotating it out of its final position.

6.15 No supply voltage available to motor

The power supply to the motor fell below a value of roughly 17 V. Deleting this bit requires a 1→0 transition for the confirmation bit in the command byte.

6.16 Upper range limit

The drive has exceeded the upper limit of the user-defined positioning range and can no longer move in the positive direction. This bit is deleted as soon as the drive is within the permissible range. If the drive is switched off in this position, the instrument may produce positioning errors when switched back on.

6.17 Lower range limit

The drive has exceeded the lower limit of the user-defined positioning range and can no longer move in the negative direction. This bit is deleted as soon as the drive is within the permissible range. If the drive is switched off in this position, the instrument may produce positioning errors when switched back on.

6.18 Actual position

In this modul the drive is sending current actual position in target-value increments

6.19 Control byte configuration

Bit	Meaning
15(MSB)	not assigned
14	not assigned
13	not assigned
12	not assigned
11	not assigned
10	not assigned
9	not assigned
8	confirmation for hardware error
7	release bit
6	manual run release
5	run with no reference loop
4	set value for reference position
3	set and save reference position
2	accept and proceed to position
1	manual run, down
0(LSB)	manual run, up

6.20 Confirmation

When this bit undergoes a 1→0 transition, all hardware errors and the error status are transferred to the error memory and deleted. The save command can be used to transfer the error memory to the internal EEPROM memory (performed automatically in firmware version 7 and up once the error is confirmed). Having the error memory analyzed by the manufacturer can be extremely helpful when performing an error search.

6.21 Release bit

If this bit is set, the drive can run. If it is deleted during a run, the drive will stop.

6.22 Manual run release

If this bit is set and the 'accept and proceed to position' bit is not set, status information from the external jog keys will be used to control the positioning unit directly.

6.23 Run with no reference loop

If this bit is set, the reference loop can be suppressed, even if it has been activated during the parameter setting process.

6.24 Set value for reference position

The drive can be assigned a reference position ('set and save reference position') when it is mounted. This reference position, which serves as the new zero position for the drive, is saved in the instrument and can be assigned a new numerical value via the control unit.

The new numerical value is written into the target position module and this bit is then activated briefly. In order to prevent an unwanted run, no other bit can be set in the command byte; otherwise the value will not be accepted.

For firmware version 7 and higher, this value should be transferred when setting the reference position for the target position, as it can now be saved permanently.

6.25 Set and save reference position

If this bit has been activated and the remaining bits in the command byte have not been set, the current position will be saved as the instrument's new zero position. All positional data now use this point as a reference. In order to prevent an unwanted run, no other bit can be set in the command byte; otherwise the value will not be accepted.

For firmware version 7 and higher (parameter software: 15507), the current position transferred in the target position module is assigned to the reference point and saved permanently.

Example: Set reference point, target position = 1000 → new actual position = 1000.

6.26 Accept and proceed to position

This bit signals the positioning unit that a valid target value has been provided. The drive will begin a new positioning run as soon as this bit is set (provided the release bit has been set). For this to occur, the release bit must be set and no errors may be active.

6.27 Manual run, down

A manual run is started if this bit is set and the 'accept position' bit has not been set. The run begins with a single increment, the length of which can be set via the 'jog key increment size' parameter. The drive then waits the amount of time specified by the 'jog key pause' parameter; afterwards the run continues at the speed set in the 'manual run' parameter until the operator disengages the key. A manual run will not be performed if the pause is set to 0 ms, in which case the run can only proceed in single increments.

6.28 Manual run, up

See 6.27 Manual run, down

6.29 Target position

This 32Bit Value will send the next position to be achieved in target value increments to the drive. When activating the 'accept and proceed to position' bit in the control word the drive will start to move towards this position. If the bit remains set, the drive will follow each change of this value immediately.

6.30 Parameters

Index	Meaning	Default	Range of values	Access
0	direction of rotation	+1	-1 = left +1 = right	R
1	direction of travel	0	-1 = left 0 = none +1 = right	R/W
2	position correction	0	0 = off; 1 = on	R/W
3	jog key operation	0	0 = off; 1 = on	R/W
4	hardware resolution	1024	1 ... 1024	R/W
5	software resolution (0.01 mm/rev.)	400	1 ... 1024	R/W
6	positioning window	min	1 ... 100 [1/1024 revolutions]	R/W
7	max. run distance, positive	9880	-100.00% ... 100.00% [0.01%]	R/W
8	max. run distance, negative	-40	-100.00% ... 100.00% [0.01%]	R/W
9	target rpm, positioning run	1000	1 ... 120.0% [0.1%]	R/W
10	target rpm, manual run	100	1 ... 120.0% [0.1%]	R/W
11	max. rpm, left	1200	1 ... 120.0% [0.1%]	R/W
12	max. rpm, right	1200	1 ... 120.0% [0.1%]	R/W
13	max. torque	1000	1 ... 100.0% [0.1%]	R/W
14	max. torque, left	1000	1 ... 100.0% [0.1%]	R/W
15	max. torque, right	1000	1 ... 100.0% [0.1%]	R/W
16	max. starting torque	1000	1 ... 125.0% [0.1%]	R/W
17	duration of starting torque	100	1 ... 1000 [ms]	R/W
18	holding torque	500	1 ... 100.0% [0.1%]	R/W
19	drag error	100	20 ... 2000 [0.01mm]	R/W
20	Min. rpm for detecting an obstacle	10	1 .. 60% [1%]	R/W

Index	Meaning	Default	Range of values	Access
21	time required to detect an obstacle	100	1 ... 500 ms	R/W
22	wait time between runs	50	20 ... 10000 ms	R/W
23	min. supply voltage	190	15.0 ... 24.0 V	R/W
24	filter value for voltage monitoring	100	100 ... 1000 [1ms]	R/W
25	loop length	100	0 ... 1000 [1/1024 revolutions]	R/W
26	jog key increment size	10	1 ... 1000 [0.01mm]	R/W
27	jog key pause	500	0 ... 1000 [ms]	R/W
28	factor for ramp length	1000	1000...5000 [1/1000]	R/W
29	limiting temperature	70	50 ... 100 [°C]	R/W
30	LSW reference position (lower 16 bit)	0	+/- 1000000 [0.01mm]	R/W
31	MSW reference position (upper 16 bit)	0		R/W
32	production date		WWYY	R
33	serial number		0 ... 30000	R
34	device type		3xx,312,315	R
35	software version		155xx, xx = software design specification	R
36	hardware version		0 ... 999	R
37	device temperature		0 ... 100 [°C]	R
38	actual rpm		1/min	R
39	max. actual torque (current)		0 ... 200.0 % [0. 1%]	R
Index	Meaning		Range of values	Access
40	run time LSW		[ms]	R
41	run time MSW		[ms]	R
42	drag position			R
43	power supply to motor		[0.1V]	R
44	motor current		[mA]	R
45	supply voltage for control unit		[0.1V]	R
46	error code			R
default	drive model			R

These parameters can be set and/or read out via the parameter module (read-only parameters are those for which access is designated as 'R'). All parameters are transferred as 16-bit integer values.

6.31 Direction of rotation

This parameter specifies the direction in which the drive rotates. A value of +1 means that the drive will rotate clockwise (with respect to the output shaft) when increasing the position, whereas a -1 causes the drive to rotate counterclockwise under the same conditions.

6.32 Direction of travel

If the length of the reference loop has been defined, this parameter establishes the direction in which the drive will approach the target position. If the direction of travel = 0, each position will be approached without a reference loop. A value of +1 indicates movement to the right (clockwise) and -1 indicates movement to the left. A reference loop is automatically inserted whenever a position has been approached from a different direction.

6.33 Position correction

If, after a correctly executed positioning run, the drive is forcibly moved out of position in the opposite direction, the drive will attempt to correct the position provided this parameter is set to 1. A value of 0 switches this function off. Using devices with an optional holding brake this parameter must be set to 0.

6.34 Jog key operation

This parameter can be used to determine whether jog key commands are sent directly to the drive. If this parameter is set to 1 and the 'accept and proceed to position' bit is not set, then drive will execute all commands entered via the jog keys. If this parameter is set to zero, jog key commands are merely signaled in the status byte. The user can then either perform a manual run using the bits in the command byte or redirect this action to a different drive.

6.35 Hardware resolution

This parameter specifies the internal resolution of the drive and is involved in the process of translating external positions into an internal position. If this parameter remains at 1024, the following parameter can be used to set the drive resolution per rotation. (400 corresponds to 400 increments per rotation or 0.01 mm/ increment at a spindle pitch of 4.0 mm.) Changing this parameter will interrupt any positioning run that is underway and may result in positioning errors.

6.36 Software resolution

This parameter, along with the preceding parameter, specifies the drive resolution per rotation when transmitting the position via the Profibus.

$$\frac{\text{increments}}{\text{rotation}} = \frac{1024 * \text{software_resolution}}{\text{hardware_resolution}}$$

The most practical approach is to leave the hardware resolution set to 1024 and then set the increments/rotation by adjusting the software resolution. Changing this parameter will interrupt any positioning run that is underway and may result in positioning errors.

6.37 Positioning window

If the discrepancy between the actual and target positions is larger than the value specified in the 'positioning window' parameter, the 'target position reached' bit will not be activated.

Values should be entered in 1/1024 rotations.

6.38 Max. run distance, positive

This parameter is used for setting the maximum run distance for positive rotation. Values should be entered as a % of the absolute run distance (256 rotations). The instrument checks to make certain that the sum of the maximum positive run distance and maximum negative run distance does not exceed 99.2%; if this is not the case, the value entered will be reduced by the appropriate amount.

6.39 Max. run distance, negative

This parameter is used for setting the maximum run distance for negative rotation. Values should be entered as a % of the absolute run distance (256 rotations). The instrument checks to make certain that the sum of the maximum positive run distance and maximum negative run distance does not exceed 99.2%; if this is not the case, the value entered will be reduced by the appropriate amount.

6.40 Target rpm, positioning run

This parameter stipulates the target rpm in 1/min for a positioning sequence. The percentage value is based on the nominal rated speed of the drive in question.

6.41 Target rpm, manual run

This parameter stipulates the target rpm for a manual run. The percentage value is based on the nominal rated speed of the drive in question.

6.42 Max. rpm, left

This parameter allows the user to set the maximum rpm for positioning sequences in which the drive is rotating counterclockwise.

6.43 Max. rpm, right

This parameter allows the user to set the maximum rpm for positioning sequences in which the drive is rotating clockwise.

6.44 Max. torque

This parameter allows the user to set the maximum torque for positioning sequences. Torque is limited by limiting the current to the motor. Values should be entered as a percentage of the nominal torque.

6.45 Max. torque, left

This parameter allows the user to set the maximum torque for positioning sequences in which the drive is rotating counterclockwise.

6.46 Max. torque, right

This parameter allows the user to set the maximum torque for positioning sequences in which the drive is rotating clockwise.

6.47 Max. starting torque

This parameter allows the user to set the maximum torque for the start of a positioning sequence, thus making it possible to overcome a large breakaway torque if necessary. The following parameter allows the user to set the duration of this starting torque.

6.48 Duration of starting torque

This parameter can be used to stipulate how long the elevated starting torque is to remain active.

6.49 Holding torque

For many applications, the drive requires a level of holding torque greater than the very low self-holding torque generated by the drive's EC motor. This parameter allows the user to set that holding torque value.

Current is then supplied to one of the motor windings when the drive is not operating. The level of holding torque should be entered as a percentage of the nominal torque. The smallest possible level of torque should be selected in order to prevent the drive from heating up unnecessarily, which would reduce the OT.

6.50 Drag error

Because the load profile changes over the course of a positioning run, it sometimes happens that the drive fails to reach its target rpm. This can lead to problems for applications involving the synchronous operation of two drives. The 'drag error' bit will be set in the status byte if, over the course of the run, the drive falls short of its theoretical position (target rpm * run time) by more than the distance specified by the 'drag error' parameter. The control unit can then often take steps to correct the situation. If relatively short distances are involved, the drive itself will attempt to compensate for the discrepancy by raising its speed by a small amount (+/- 1 [1/min]). This corrective function can be deactivated by setting the drag error distance to zero.

6.51 Min. rpm for detecting an obstacle

The drive registers an obstacle if the actual rpm = 0 [1/min] or if the drive speed falls below a certain percentage of the target rpm for a specific amount of time. This parameter allows the user to set that percentage value. If the instrument detects an obstacle, the current positioning run will be aborted and the 'positioning error' and 'positioning run aborted' bits are set in the status byte.

6.52 Time required to detect an obstacle

This parameter specifies how long the drive speed must be less than the minimum rpm described above before the instrument registers an obstacle.

6.53 Wait time between runs

The parameter specifies the minimum amount of time (in ms) that the drive will pause before reversing its course.

6.54 Min. supply voltage

This parameter indicates the voltage at which the 'motor supply voltage' bit in the status byte is activated. No positioning runs can be executed if this bit is not activated. When setting the voltage level, it is important to consider that, due to a number of different components, the power supply to the motor is lower than the voltage applied externally. The positioning sequence will not be aborted if the power supply falls below the required voltage by only a small amount during a run.

6.55 Filter value for voltage monitoring

This parameter allows operators to bridge brief voltage dips, such as may occur as a result of the initial current. The 'motor supply voltage OK' bit is only set when the voltage dip lasts longer than the amount of time specified in this parameter.

6.56 Loop length

The 'direction of travel' parameter can be used to instruct the drive to approach all positions from the same direction. If a positioning run is performed in the opposite direction, the drive will first move past its target and then perform a second positioning sequence, which takes it to the desired target position. This parameter allows the user to specify the length of this loop (value should be entered in hardware increments).

6.57 Jog key increment size

Briefly depressing the jog keys causes the drive to move a defined distance in a given direction. This parameter allows the user to specify this distance (value should be entered in software increments).

6.58 Jog key pause

Briefly depressing a jog key causes the drive to move a defined distance, after which it will wait for the amount of time specified by this parameter and then start again in the corresponding direction at the speed indicated in the 'target rpm, manual run' parameter. Manual operation is suppressed if the jog key pause is set to zero, allowing the jog keys to function only in increments.

6.59 Factor for ramp length

This parameter allows the user to influence the length of the deceleration ramp for applications in which large moments of inertia need to be overcome. The value should be entered as an integer, where 1000 corresponds to a factor of 1.0 and 800 corresponds to a value of 0.8, i.e., a shorter ramp. Positioning times will be decreased if the ramp is reduced; the risk of positioning errors increase, however.

6.60 Limiting temperature

The drive is equipped with a temperature sensor. If the measured temperature exceeds the temperature limit specified by this parameter, the 'temperature exceeded' bit in the status byte is activated and the drive stops. No new runs may be performed until the drive temperature has returned to below the temperature limit.

6.61 Reference position MSW

This parameter can be used to read out and/or set the upper 16 bits of the reference position value. The reference position is the position value that the drive displays when it reaches the point corresponding to its assigned reference position (internal zero point).

6.62 Reference position LSW

This parameter can be used to read out and/or set the upper 16 bits of the reference position value. The reference position is the position value that the drive displays when it reaches the point corresponding to its assigned reference position (internal zero point).

6.63 Production date

This parameter is available only for read-out. The manufacturer has saved the production date plus the year and day of manufacture in this parameter as an aid in documenting the technical status of the instrument.

6.64 Serial number

The serial number is stored in this parameter as an aid in documenting the technical status of the instrument.

6.65 Device type

The device model is stored here as a hexadecimal figure.

Format: xxxy (xxx = design and torque, y = diameter of the output shaft \$E = 14 mm, 8 = 8 mm).

6.66 Software version

This parameter contains the version number for the firmware stored on the instrument. The output value is given as a decimal 155xx(xx = firmware design specification).

6.67 Hardware version

This parameter contains the design specification number for the instrument.

6.68 Device temperature

This parameter can be used for querying the current temperature measured inside the instrument (in °C).

6.69 Actual rpm

This parameter can be used for querying the current drive speed (output in 1/min) while a positioning run is still in progress. Values should be entered in 1/min.

6.70 Max. actual torque (current)

Torque is monitored throughout a positioning sequence from the end of the initial torque period until the current is slowed. The highest value measured here is used to calculate maximum torque. This parameter can be used to monitor the mechanical equipment in that the value will increase when motion becomes difficult. This increase would then serve as a reason for inspecting the equipment.

6.71 Run time MSW

This parameter reads out the upper 16 bits of the run time (in ms) for the most recent positioning sequence.

6.72 Run time LSW

This parameter reads out the lower 16 bits of the run time (in ms) for the most recent positioning sequence.

6.73 Drag position

This parameter reads out the difference between the current and theoretical actual positions (target rpm (1/min) * time).

6.74 Motor supply voltage

This parameter reads out the motor supply voltage (measured internally) in 0.1V increments. While the measured value can then serve as an indicator, the measurement precision, however, is very poor (ca. +/-1V).

6.75 Motor current

This parameter reads out the present motor current in mA.

6.76 Supply voltage for control unit

This parameter can be used for reading out the supply voltage to the drive control unit. Resolution: 0.1V; precision: approx. +/- 1V.

6.77 Error code

This byte is used as a more precise diagnostic tool for troubleshooting a number of different errors, especially hardware errors. The meanings of individual bits are shown in the following table:

Bit	Hexadec.	Meaning
15(MSB)	0x8000	learn mode active (for manufacturer's use only)
14	0x4000	for internal use
13	0x2000	temperature too high
12	0x1000	error in motor memory
11	0x0800	error in DP address memory
10	0x0400	device parameters have been reset
9	0x0200	supply voltage to motor was less than 16V
8	0x0100	saved parameters incorrect
7	0x0080	Profibus chip is registering an error
6	0x0040	Profibus communication disrupted
5	0x0020	release was reset during a run
4	0x0010	invalid target position = outside of positioning range
3	0x0008	invalid parameter values
2	0x0004	encoder error
1	0x0002	supply voltage to motor is too low
0(LSB)	0x0001	actual position lies outside of positioning range

A few of these errors prevent the drive from performing any further runs, in which case the error code byte must be reset. This is accomplished by resetting the release in the command byte, an action that also saves the most recent error code in the internal EEPROM, where the manufacturer can access it at a later date for determining the mechanism, if necessary, by which a given error occurred.

6.78 Changing parameter values

Change parameter values by first using the index to select the parameter in question. The current value is reported in the 'Data In' module. The 'Current Index' module returns the set index as an echo signal and the new value is written in the 'Data Out' module. The instrument then checks the plausibility of the new value and, if it detects an error, sets the 'invalid target and/or parameter value' bit in the status byte. If it does not set this bit, the MSB(0x80) in the index byte can be set in order to transmit the value to the instrument. If the value is accepted, it is then read out in the 'Data In' module. The MSB(0x80) in the index byte must now be reset to prevent any accidental writing processes when changing the index byte.

7 Backing up parameter data and the error memory

A special command allows the user to store parameter data in the EEPROM area, a process which does not affect the functioning of the instrument for the user. Every time the Profibus DP starts up, parameter data are reloaded through the bus, making saved data are irrelevant. What is important, however, is saving data when hardware errors crop up during operation. In this case, this procedure can be used to transfer the contents of the error memory to the EEPROM.

Parameter index = 0x7D (dec 125)
Parameter data = 0x55 (dec 85)

This back-up procedure takes less than 1 s, after which the drive must register the value '0000' as parameter data.

NOTICE

Important: Do not turn off the instrument while backing up data, as this could cause important parameter data to be deleted.

8 Technical data

For additional specifications and dimension drawings, please visit our website at <https://www.halstrup-walcher.de/en/products/drive-technology/>



8.1 Drive speed and torque PSE

drive model	3110-14	3125-14	3210-14	3218-14	PSE3410
nominal output torque (30 % OT)	10 Nm	25 Nm	10 Nm	18 Nm	10 Nm
temporary breakaway torque			12,5 Nm	22,5 Nm	12,5Nm
self-holding torque (w/ current)	6 Nm	12,5 Nm	5 Nm	9 Nm	5 Nm
nominal output speed	30 U/min	12 U/min	30 U/min	17 U/min	80 U/min

drive model	3310-14	3325-14	PSE3410	PSE3418
nominal output torque (30 % OT)	10 Nm	25 Nm	10 Nm	18 Nm
temporary breakaway torque	12,5 Nm	27,5 Nm	12,5Nm	22,5Nm
self-holding torque (w/ current)	5 Nm	12,5 Nm	5 Nm	9 Nm
nominal output speed	25 U/min	10 U/min	80 U/min	60 U/min

8.2 Drive speed and torque PSE and PSS

drive model	301-x 311-x	302-x 312-x	305-x 315-8	322-14 332-14	325-14 335-14	328-14	338-14
nominal output torque (30 % OT)	1 Nm	2 Nm	5 Nm	2 Nm	5 Nm	8 Nm	7 Nm
temporary breakaway torque	1,25 Nm	2,5 Nm	6,25 Nm	2,5 Nm	6,25 Nm	10 Nm	8 Nm
self-holding torque (w/ current)	0,5 Nm	1 Nm	2,5 Nm	1 Nm	2,5 Nm	4,5 Nm	3 Nm
nominal output speed	210 U/min	100 U/min	40 U/min	150 U/min	68 U/min	45 U/min	45 U/min

8.3 Drive speed and torque PSW

drive model	301-x 311-x	302-x 312-x	305-x 315-8	322-14 332-14	325-14 335-14	328-14	3318-14
nominal output torque (30 % OT)	1 Nm	2 Nm	5 Nm	2 Nm	5 Nm	8 Nm	18 Nm
temporary breakaway torque	1,25 Nm	2,5 Nm	6,25 Nm	2,5 Nm	6,25 Nm	10 Nm	22,5 Nm
self-holding torque (w/ current)	0,5 Nm	1 Nm	2,5 Nm	1 Nm	2,5 Nm	4,5 Nm	9 Nm
nominal output speed	180 U/min	90 U/min	35 U/min	125 U/min	50 U/min	35 U/min	10 U/min

8.4 Ambient conditions

ambient temperature	0 °C to +45 °C		
storage temperature	-10 °C to +70 °C		
shock resistance according to DIN IEC 68-2-27	50 g 11 ms		
resistance to vibration according to DIN IEC 68-2-6	10 Hz to 55 Hz 1.5 mm 55 Hz to 1000 Hz 10 g 10 Hz to 2000 Hz 5 g		
EMC standards	CE		
conformity	CE / UKCA		
protection class	PSE		IP 54 / IP 65
	PSS		IP 65
	PSW		IP 66 (in operation)
duty cycle	Device model	Duty cycle in %	Base time in sec.
	PSE34xx	20	300
	PSE30xx to 33xx	30	300
	PSS	20	600
	PSW	20	600

8.5 Electrical data

nominal power output	PSx30x, PSx31x, PSE31xx	25 W with 30 % duty cycle
	PSx32x, PSx33x	35 W with 30 % duty cycle
	PSx34xx	100 W with 20 % duty cycle
supply voltage	24 VDC \pm 10 % (supply voltages for motor and control unit are galvanically isolated) advice: use regulated power supplies	
nominal current, control unit	0.15 A	
nominal current, motor	PSx30x, PSx31x, PSE31xx	2.4 A
	PSx32x, PSx33x	3.1 A
	PSE34xx	7.8 A
positioning resolution	0.9°	
positioning accuracy	0.9°	
Profibus DP	addresses set via decade switches 0...99 9.6, 19.2, 45.45, 93.75, 187.5, 500, 1500, 3000, 6000, 12000 kBaud	
absolute value acquisition	optical - magnetic	

8.6 Physical data

positioning range	250 usable rotations, no mechanical limits measuring system has a span of 256 turns, minus 3 turns security stock at upper and lower range limit	
torsional rigidity (angle of rotation when switching from operation without backlash to maximum torque)	max. 0.2°	
gear backlash (without spindle compensation run)	max. 0.5°	
spindle lash compensation	automatic loop after every positioning run (may be deactivated)	
output shaft	PSE30x-8 PSE31x-8	8H9 hollow shaft with adjustable collar
	PSE30x-14, PSE31xDP-, PSE32x, PSE33x	14H7 hollow shaft with adjustable collar
	PSE338 PSE31xx PSE32xx PSE33xx PSE34xx	14H7 hollow shaft with clamp and feather key
	PSS3xx-8 PSW3xx-8	8H9 hollow shaft with adj. collar or 8h8 solid shaft
	PSS3xx-14 PSW3xx-14	14H7 hollow shaft with adj. collar or 14h8 solid shaft
recommended diameter of the spindle head	according to the hollow shaft diameter with an interference fit of h9	
Vibration emission	not in the harmful range	
Noise emission	not in the harmful range	
maximum radial force	40 N	
maximum axial force	20 N	
dimensions (l x w x h)	see catalog data on our website	
weight (approx.)	PSx30x-8	650 g
	PSx30x-14, PSx32x	1200 g
	PSx31x-8	700 g
	PSx31x-14, PSx33x	700 g
	PSE31xx	1200 g
	PSE34xx	1900 g

9 Certificate of Conformity



EU-Konformitätserklärung EU Declaration of Conformity

Company	halstrup-walcher GmbH, Stegener Str. 10, 79199 Kirchzarten erklärt als Hersteller in alleiniger Verantwortung, dass das Produkt declares as manufacturer under sole responsibility, that the product
Product	Positionierantriebe Baureihen PSE3xx, PSS3xx, PSW3xx Positioning Systems Series PSE3xx, PSS3xx, PSW3xx
Regulations	den folgenden Europäischen Richtlinien entspricht: conforms to following European Directives: EMC 2014/30/EU RoHS 2011/65/EU
Standards	angewandte harmonisierte Normen: applied harmonized standards: EN IEC 61800-3:2018 EN IEC 63000:2018
Certification	EU Konformitätserklärung ausgestellt von EC Type Examination Certificate issued by



Geschäftsführer

Managing Director

Kirchzarten,

14. Okt. 2020

14. Oct. 2020

halstrup-walcher GmbH
Stegener Straße 10
79199 Kirchzarten

Telefon: +49 (0) 7661 3963-0
Fax: +49 (0) 7661 3963-99
E-Mail: info@halstrup-walcher.de

Geschäftsführer: Jürgen Walcher, Christian Sura
Handelsregister Freiburg HRB 2209
Umsatzsteuer-ID-Nr. DE 811169901



UK Declaration of Conformity

Company halstrup-walcher GmbH, Stegener Str. 10, 79199 Kirchzarten, Germany
declares as manufacturer under sole responsibility, that the product

Product Positioning System Models PSE3xx / PSS3xx / PSW3xx

Regulations is in conformity with relevant statutory requirements:

EMC Electromagnetic Compatibility Regulations 2016 No. 1091
RoHS RoHS Regulations 2012 No. 3032

Standards applied standards:
EN 55011:2016+A1:2017; EN 61000-6-2:2005; EN 61800-3:2004/ A1:2012
EN IEC 63000:2018

Declaration signed for and on behalf of

Geschäftsführer

Managing Director

Kirchzarten, 26. Jan. 2022

halstrup-walcher GmbH
Stegerer Straße 10
79199 Kirchzarten

Telefon: +49 (0) 7661 3963-0
Fax: +49 (0) 7661 3963-99
E-Mail: info@halstrup-walcher.de

Geschäftsführer: Jürgen Walcher, Christian Sura
Handelsregister Amtsgericht Freiburg HRB 2209
Umsatzsteuer-ID-Nr. DE 811169901

